

Designing With Caddock MP Series TO-Style Heat Sink Mountable Power Film Resistors

Contents

- 1.0 Introduction (Page 1)
- 2.0 Understanding Power Rating (Page 1)
- 3.0 Thermal Design (Page 2)
- 4.0 Electrical Design (Page 3)
- 5.0 Applying Thermal and Electrical Design (Page 4)
- 6.0 Quick Guide for Heat Sink Selection (Page 5)
- 7.0 Assembly Materials and Techniques (Page 7)
- 8.0 Lead Forming (Page 9)
- 9.0 Thermal Design Verification (Page 10)

1.0 INTRODUCTION

These notes will provide a design tool for the conservative and reliable application of Caddock TO-Style Heat Sink Mountable Power Film Resistors. This family of resistors includes the familiar TO-126, TO-220 and TO-247 style packages, which are commonly used for power semiconductor devices. These resistors allow a designer to apply his thermal design experience gained from using these power semiconductor packages, and utilize off-the-shelf thermal materials, thermal hardware, and mounting hardware in the application of these TO-Style resistors.

2.0 UNDERSTANDING POWER RATING

The maximum power rating of these resistors is specified with the case temperature (T_C) at 25°C. This is the same method established and proven by the power semiconductor industry. Case temperature is the temperature measured at the center of the resistor mounting surface which is in contact with the heat sink, while the resistor is under electrical load. Case temperature must not be confused with the molded body temperature, the tab temperature, the lead temperature or the ambient temperature (Figure 1).

Using case temperature we can determine the temperature of the resistor film (T_J). This is important since early device failures are usually traced to excessive temperatures of the resistor film. Excessive film temperatures will cause a drift of the resistance value or reduced component life. Proper thermal design,

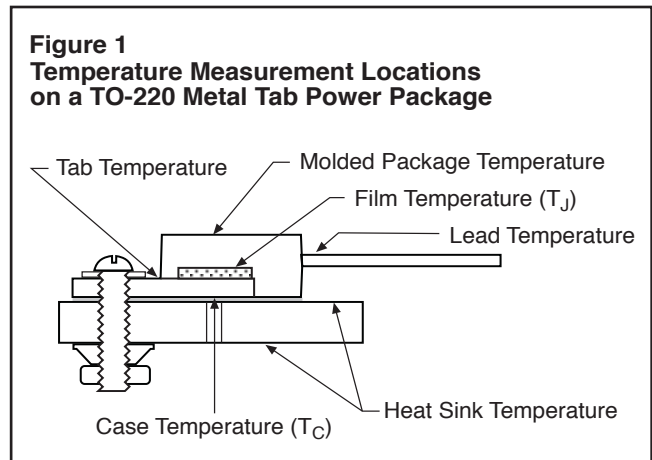

followed by temperature measurements to verify the design, and consistent mounting procedures will avoid these problems.

The film temperature (T_J) is related to the case temperature (T_C) by the parameter “thermal resistance” ($R_{\theta JC}$). Thermal resistance is expressed in °C/W. In other words, the thermal resistance ($R_{\theta JC}$) is the temperature rise (°C) between “J” (film) and “C” (case) per watt applied. Each Caddock TO-Style power film resistor has a specified thermal resistance (Table 1).

Table 1

Model	Package Style	Power Rating 25°C Case	$R_{\theta JC}$ (°C/W)	T_J max (°C)
MP725	D-Pak	25 Watts	5.00	150
MP825	TO-126	25 Watts	5.00	150
MP915	TO-126	15 Watts	8.33	150
MP820	TO-220	20 Watts	7.50	175
MP821	TO-220	20 Watts	7.50	175
MP850	TO-220	50 Watts	2.50	150
MP916	TO-220	16 Watts	7.81	150
MP925	TO-220	25 Watts	5.00	150
MP930	TO-220	30 Watts	4.17	150
MP2060 0.005Ω	TO-220	18 Watts	6.94	150
MP2060 0.010Ω	TO-220	36 Watts	3.47	150
MP2060 0.015Ω	TO-220	54 Watts	2.31	150
MP2060 ≥0.020Ω	TO-220	60 Watts	2.08	150
MP9100	TO-247	100 Watts	1.50	175

3.0 THERMAL DESIGN

As stated earlier, the power rating of a TO-Style resistor is established at 25°C case temperature. However, in nearly all real-life applications the case temperature will be higher than 25°C. A typical thermal system has three thermal resistances, acting in series, which restrict the flow of heat from the film to the ambient air (Figure 2). These three thermal resistances are:

Thermal Resistance 1: Power Resistor Package ($R_{\theta JC}$) taken from Caddock Data Sheet or Table 1.

Thermal Resistance 2: Thermal Interface Material ($R_{\theta CS}$) must be taken from manufacturer's data sheet. Consider actual contact area.

Thermal Resistance 3: Heat Sink ($R_{\theta SA}$) taken from heat sink manufacturer. Air flow must be considered.

We can determine the maximum power dissipation using Equation 1.

$$\text{Equation 1: } P_D = \frac{(T_J - T_A)}{R_{\theta JC} + R_{\theta CS} + R_{\theta SA}}$$

- P_D Power dissipation (watts)
- T_J Resistor film temperature (°C)
- T_A Ambient temperature (maximum) (°C)
- $R_{\theta JC}$ Thermal resistance of the Power Resistor Package (°C/W)
- $R_{\theta CS}$ Thermal resistance of the Thermal Interface Material (°C/W)
- $R_{\theta SA}$ Thermal resistance of the Heat Sink (°C/W)

Example:

An MP9100 resistor is used with thermal grease on a heat sink. The thermal grease has a thermal resistance of approximately 1°C/W. The manufacturer of the heat sink states the thermal resistance is 7.5°C/W. The maximum ambient temperature is 55°C. What is the maximum power the resistor can dissipate?

- P_D = Power dissipation (to be determined)
- T_J = 175°C (MP9100 from Table 1)
- T_A = 55°C (Maximum ambient temperature)
- $R_{\theta JC}$ = 1.5°C/W (MP9100 from Table 1)
- $R_{\theta CS}$ = 1°C/W (Thermal grease)
- $R_{\theta SA}$ = 7.5 °C/W (Heat sink)

Using Equation 1:

$$P_D = \frac{(175^\circ\text{C} - 55^\circ\text{C})}{(1.5^\circ\text{C/W} + 1^\circ\text{C/W} + 7.5^\circ\text{C/W})}$$

$$P_D = 12.0 \text{ watts (maximum power dissipation)}$$

In this example, the MP9100 which is rated at 100 watts at 25°C case temperature, can safely dissipate 12.0 watts. The actual power dissipation capability of the resistor is greatly dependent on the heat sink, thermal interface material, ambient temperature and proper mounting.

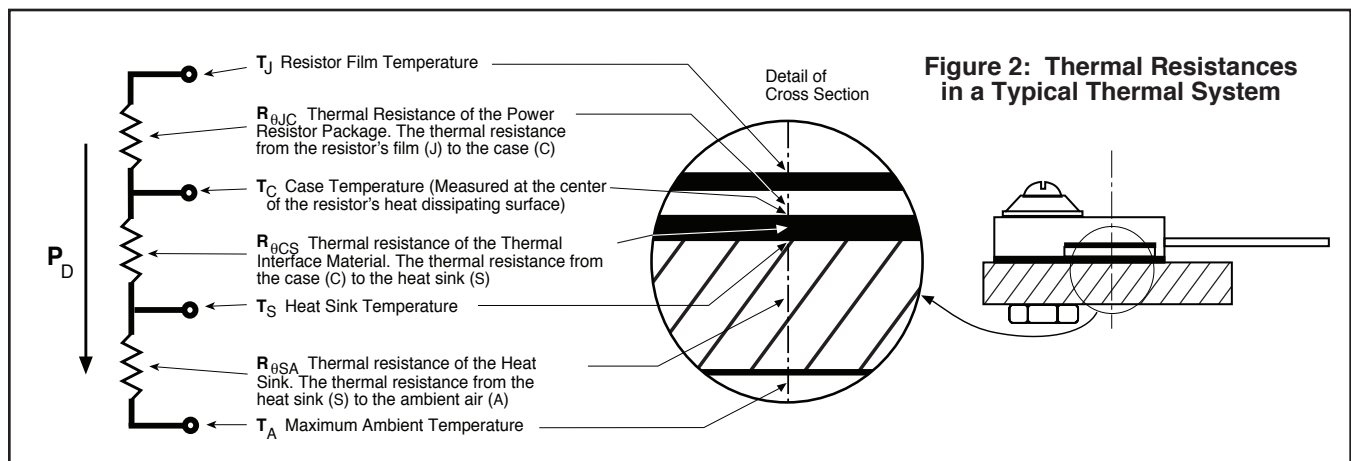

4.0 ELECTRICAL DESIGN

For your application, begin by first determining the average and maximum power dissipation to be applied to the resistor and the maximum ambient temperature. DC and standard AC RMS power levels, without surges, require no further special consideration.

Pulses or transients require special consideration since they cause instantaneous temperature rise of the resistor film. Caddock Applications Engineering can guide you through these considerations.

For applications with transients, pulses or surges the following must be considered:

1. Do not exceed a peak voltage of twice the normal rated operating voltage of the device.

MODEL	PEAK VOLTAGE (do not exceed)
MP725	400 V peak
MP825	600 V peak
MP915	400 V peak
MP820	600 V peak
MP850	600 V peak
MP925	1000 V peak
MP930	500 V peak
MP2060	500 V peak
MP9100	750 V peak

2. For greatest pulse handling use the MP9100, MP2060, MP925, MP930 or MP850. These resistors have the largest resistance film elements.
3. Using Figure 3, estimate the energy (E) and the pulse duration (t) for a single pulse in your application.

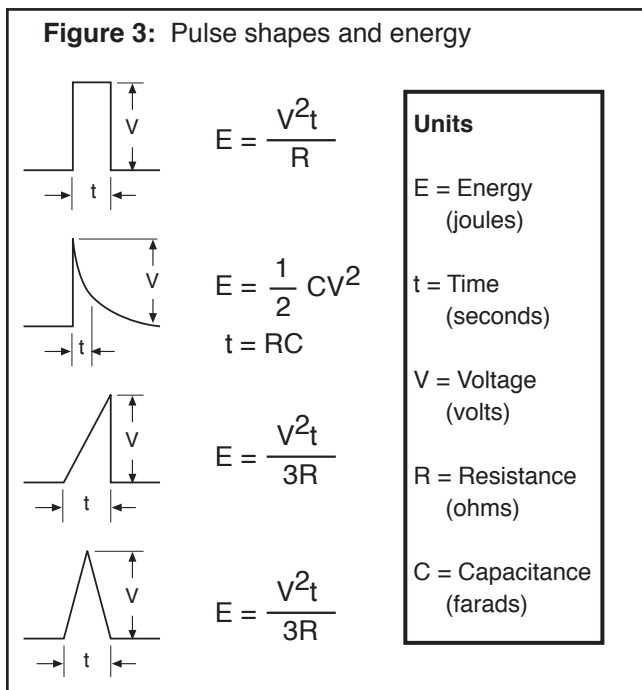

4. Refer to the Single Event Pulse Chart (Figure 4). On this chart find the point where the energy (E) and time (t) coincide. "Qualify" that this point falls below the maximum pulse energy curve for the product you have selected. This "qualified" pulse is valid for film temperatures up to 150°C. "Qualified" single event pulses determined from the chart do not require additional heat sinking.

5. Multiple pulse applications: When multiple "qualified" pulses occur at a uniform pulse frequency it is important to determine average power for the selection of the proper power resistor model, the proper heat sink and thermal interface material. The average power dissipation for uniformly spaced pulses can be calculated from the following formula:

Equation 2: $P_{ave} = E f$

$P_{ave} = P_D$ = average power dissipation (watts)

E = single pulse energy (Joules)

f = frequency (pulses per second)

Select the power resistor model, heat sink and thermal interface material based on the average power (P_D) and the maximum ambient temperature using Equation 1. For oddly spaced pulses within a pulse string consult Caddock Applications Engineering.

6. Longer duration pulses, exceeding 100 milliseconds, are not shown in Figure 4 (single event pulse chart). A heat sink will thermally assist pulses of this duration. For reference, the thermal time constant of the resistance film is approximately 150 μ seconds and the time constant for the entire system (heat flow from element to mounting surface) is approximately 50 milliseconds. For pulses over 100 milliseconds refer to the momentary overload specification on the product data sheet. Derate this overload specification based on the case temperature.

Always verify designs with pulse and surge conditions through thorough testing of the design at maximum operating temperature and maximum pulse loading (or some margin above maximum pulse loading). Damage to the resistor by excessive pulse loading will be indicated by an increasing resistance of the resistor.

Figure 4: Single Event Pulse For Caddock TO-Style Power Film Resistors

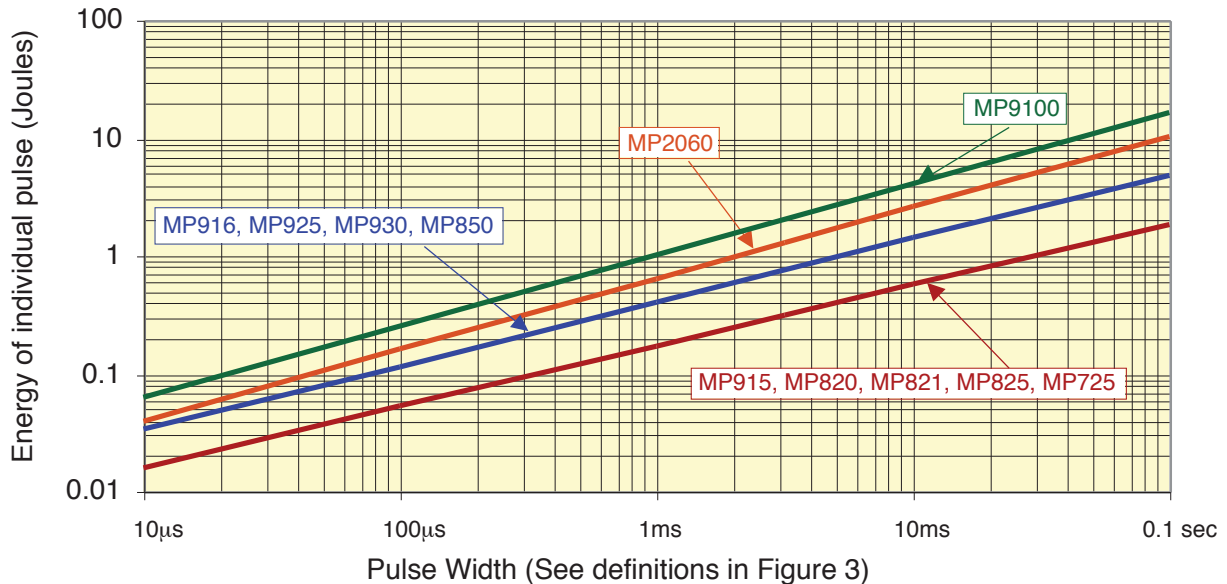

5.0 APPLYING THERMAL AND ELECTRICAL DESIGN

The following example applies the principles explained in the prior sections.

Example:

An MP850-300Ω-1% has been selected. A 5µf capacitor charged to 150 volts will be discharged through the resistor at 100 Hz. The maximum ambient temperature is 75°C.

1. The MP850 is rated for 300 volts continuous, or 600 volts peak, so the peak voltage level of 150 volts is acceptable.

2. The energy stored in the capacitor is:

$$\begin{aligned} E &= 1/2 C V^2 \text{ (from Figure 3)} \\ &= (1/2) \times (5 \text{ E-}6) \times (150)^2 \\ &= 0.056 \text{ Joules} = 56 \text{ mJ} \end{aligned}$$

$$\begin{aligned} t &= R C \text{ (from Figure 3)} \\ &= (300) \times (5 \text{ E-}6) \\ &= 0.0015 \text{ seconds} = 1.5 \text{ mS} \end{aligned}$$

From the chart (Figure 4) the MP850 is rated 500 mJ for a pulse width of 1.5 ms, so the 56 mJ pulse is well below the maximum rating for the MP850.

3. The average power is:

$$\begin{aligned} P_{ave} &= E f \text{ (Equation 2)} \\ P_{ave} &= 0.056 \text{ Joules} \times 100 \text{ Hz} \\ P_{ave} &= P_D = 5.6 \text{ watts} \end{aligned}$$

4. The heat sink thermal resistance that is required, using Equation 1:

$$\begin{aligned} P_D &= 5.6 \text{ watts} \\ T_J &= 150^\circ\text{C} \text{ (MP850 from Table 1)} \\ T_A &= 75^\circ\text{C} \text{ (Ambient temperature)} \\ R_{\theta JC} &= 2.5^\circ\text{C/W} \text{ (MP850 from Table 1)} \\ R_{\theta CS} &= 1^\circ\text{C/W} \text{ (Assumed for thermal grease)} \\ R_{\theta SA} &= \text{To be determined} \end{aligned}$$

Using Equation 1:

$$5.6 \text{ W} = \frac{(150^\circ\text{C} - 75^\circ\text{C})}{(2.5^\circ\text{C/W} + 1^\circ\text{C/W} + R_{\theta SA})}$$

$$R_{\theta SA} = 9.9^\circ\text{C/W}$$

Therefore the heat sink selected must have a thermal resistance of 9.9°C/W or less.

6.0 QUICK GUIDE FOR HEAT SINK SELECTION

The Heat Sink Selection Tables (Tables 2A, 2B and 2C) are provided as a quick reference for selecting a heat sink. These tables assume using a thermal interface material, such as thermal grease, with a thermal resistance of 1°C/W.

Using Tables 2A, 2B or 2C to select a heat sink

To select a heat sink when power dissipation and ambient temperature are known, use the following procedure:

1. Select the table (Table 2A, 2B or 2C) with the same or higher ambient temperature as in your application.
2. Find the resistor model you have chosen.
3. Follow that row across until you find a power dissipation equal to, or slightly greater than the power level in your application.
4. The number at the top of this column is the thermal resistance for the heat sink required for your application.

Using Tables 2A, 2B or 2C to determine maximum power with a known heat sink

To determine the maximum power with a known heat sink and ambient temperature, use the following procedure:

1. Select the table (Table 2A, 2B or 2C) with the same or higher ambient temperature as in your application.
2. Along the top row of the chart, find the thermal resistance that is equal to, or slightly higher than the heat sink you are using.
3. Follow that column down to the row for the resistor model you have chosen.
4. That power rating from the table represents the maximum continuous power that should be applied.

Table 2A

25°C Ambient Temperature
(Thermal Interface $R_{\theta CS}=1.0^{\circ}\text{C/W}$)

Heat sink ($R_{\theta sa}$)	2°C/W	5°C/W	10°C/W	15°C/W	25°C/W
MP820	14.3 W	11.1 W	8.1 W	6.4 W	4.5 W
MP821	14.3 W	11.1 W	8.1 W	6.4 W	4.5 W
MP825	15.6 W	11.4 W	7.8 W	6.0 W	4.0 W
MP850	22.7 W	14.7 W	9.3 W	6.8 W	4.4 W
MP915	11.0 W	8.7 W	6.5 W	5.1 W	3.6 W
MP916	11.6 W	9.1 W	6.7 W	5.3 W	3.7 W
MP925	15.6 W	11.4 W	7.8 W	6.0 W	4.0 W
MP930	17.4 W	12.3 W	8.2 W	6.2 W	4.1 W
MP2060 0.005Ω	12.6 W	9.7 W	7.0 W	5.4 W	3.8 W
MP2060 0.010Ω	19.3 W	13.2 W	8.6 W	6.4 W	4.2 W
MP2060 0.015Ω	23.5 W	15.0 W	9.4 W	6.8 W	4.4 W
MP2060 ≥0.020Ω	24.6 W	15.5 W	9.6 W	6.9 W	4.5 W
MP9100	33.3 W	20.0 W	12.0 W	8.6 W	5.5 W

Table 2B

50°C Ambient Temperature
(Thermal Interface $R_{\theta CS}=1.0^{\circ}\text{C/W}$)

Heat sink ($R_{\theta sa}$)	2°C/W	5°C/W	10°C/W	15°C/W	25°C/W
MP820	11.9 W	9.3 W	6.8 W	5.3 W	3.7 W
MP821	11.9 W	9.3 W	6.8 W	5.3 W	3.7 W
MP825	12.5 W	9.1 W	6.3 W	4.8 W	3.2 W
MP850	18.2 W	11.8 W	7.4 W	5.4 W	3.5 W
MP915	8.8 W	7.0 W	5.2 W	4.1 W	2.9 W
MP916	9.3 W	7.2 W	5.3 W	4.2 W	3.0 W
MP925	12.5 W	9.1 W	6.3 W	4.8 W	3.2 W
MP930	13.9 W	9.8 W	6.6 W	5.0 W	3.3 W
MP2060 0.005Ω	10.1 W	7.7 W	5.6 W	4.4 W	3.0 W
MP2060 0.010Ω	15.5 W	10.6 W	6.9 W	5.1 W	3.4 W
MP2060 0.015Ω	18.8 W	12.0 W	7.5 W	5.5 W	3.5 W
MP2060 ≥0.020Ω	19.7 W	12.4 W	7.6 W	5.5 W	3.6 W
MP9100	27.8 W	16.7 W	10.0 W	7.1 W	4.5 W

Table 2C

75°C Ambient Temperature
(Thermal Interface $R_{\theta CS}=1.0^{\circ}\text{C/W}$)





Heat sink ($R_{\theta sa}$)	2°C/W	5°C/W	10°C/W	15°C/W	25°C/W
MP820	9.5 W	7.4 W	5.4 W	4.3 W	3.0 W
MP821	9.5 W	7.4 W	5.4 W	4.3 W	3.0 W
MP825	9.4 W	6.8 W	4.7 W	3.6 W	2.4 W
MP850	13.6 W	8.8 W	5.6 W	4.1 W	2.6 W
MP915	6.6 W	5.2 W	3.9 W	3.1 W	2.2 W
MP916	6.9 W	5.4 W	4.0 W	3.1 W	2.2 W
MP925	9.4 W	6.8 W	4.7 W	3.6 W	2.4 W
MP930	10.5 W	7.4 W	5.0 W	3.7 W	2.5 W
MP2060 0.005Ω	7.5 W	5.8 W	4.2 W	3.3 W	2.3 W
MP2060 0.010Ω	11.6 W	7.9 W	5.2 W	3.9 W	2.5 W
MP2060 0.015Ω	14.1 W	9.0 W	5.6 W	4.1 W	2.6 W
MP2060 ≥0.020Ω	14.8 W	9.3 W	5.7 W	4.1 W	2.7 W
MP9100	22.2 W	13.3 W	8.0 W	5.7 W	3.6 W

COMMONLY AVAILABLE HEAT SINK SURFACES

All Caddock TO-Style resistor packages have the resistor element electrically isolated from the heat sink mounting surface. Therefore, the chassis, metal panels or PC board metallization can effectively be utilized for heat sinking. The following are typical thermal resistances for commonly available heat sinking surfaces.

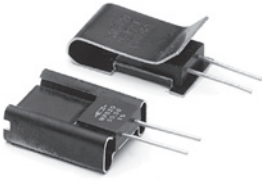
- 40°C/W Printed Circuit Board (glass epoxy)
1" X 1" pad, 2 oz. Copper
- 2.5°C/W Aluminum Chassis
6" x 4" X 2" X 0.040"
- 2.0°C/W Aluminum Chassis
7" x 5" X 2" X 0.040"

- 2.9°C/W Aluminum Sheet
6" X 4" X 3/16"
Vertically oriented
- 3.5°C/W Aluminum Sheet
6" X 4" X 3/32"
Vertically oriented
- 6.5°C/W Aluminum Sheet
2" X 2" X 3/32"
Vertically oriented

Illustration	R _{θSA} Convection	R _{θSA} 200 FPM Airflow	Comments
	30°C/W to 45°C/W	25°C/W to 30°C/W	Check to see if the clip is made to apply pressure to the molded body or on a metal tab. Metal tab clips will work for the MP820 and MP821 only. Make sure that the power resistor has full contact with the heat sink, and adequate pressure is applied.
	25°C/W Typical	8°C/W to 10°C/W	Most of these heat sinks have clips designed for standard TO-220 with tabs and are good for MP820 and MP821 only!
	20°C/W to 30°C/W	7°C/W to 10°C/W	Stamped heat sinks with nut and bolt for mounting. See pages 8-10 for proper screw mounting guidelines.
	20°C/W Typical	3°C/W to 6°C/W	Pin fin heat sinks similar to those used for micro-processors are now available for TO-220 packages. These provide large surface area for efficient cooling with airflow.
	15°C/W Typical	3°C/W to 7°C/W	Extruded multi-fin heat sinks. Available for nut and bolt assembly or clips. Generally the entire mounting surface must be in contact with the heat sink. Resistor models with heavy copper tabs (MP820/MP821) can be more forgiving since the heavy copper will spread the heat more effectively.

7.0 ASSEMBLY MATERIALS AND TECHNIQUES

Due to variations in the mating surfaces between the resistor package and the heat sink air voids are created. Since the thermal resistance of air is very high (1200°C/W/in), these voids will substantially degrade performance. A 0.001" air gap under a TO-220 device will cause a 10°C/W rise in resistor temperature. Therefore, it is important to use a thermal interface material to fill these air voids. Several materials are available to reduce thermal resistance between the resistor and heat sink surface.

All Caddock MP Series products have electrical isolation between the case and the resistor element, therefore, thermal interface materials do not need to be electrically insulating.

Thermal grease is a combination of thermally conductive particles combined with a fluid forming a grease-like consistency. The fluid has typically been a silicone oil, however there are now very good "non-silicone" thermal greases. Thermal grease has been used for many years and typically has among the lowest thermal resistances of all thermal materials available. There are a number of things that must be considered to provide optimum performance and avoid problems.

1. The heat sink surface area must be free of dirt particles, scratches, dents, voids, and burrs. It is recommended that the surface flatness be less than 0.001 in/in and surface finish in the range of 15 to 60 microinches.
2. Generally, the entire mounting surface of the Caddock TO-Style Power Resistor must be in thermal contact with the heat sink. Resistor models with heavy copper tabs (MP820/MP821) can be more forgiving, since the heavy copper tab will spread the heat more effectively.
3. Thermal grease must be applied thinly and evenly over the entire contact area. Never apply a thick coating and try to press it flat. Thermal grease usually flows poorly and this will lead to breakage of the part. Also a thick grease layer leads to poor heat transfer. To determine the correct amount and application procedure, follow the manufacturer's recommendations. Verify your procedure with actual temperature measurements.
4. Proper mounting pressure must be maintained. Insufficient mounting pressure can significantly increase thermal resistance. Mounting torque is addressed later in this section.

5. At prolonged high temperatures the silicone in silicone greases can separate and migrate, coating nearby components. This migration increases the thermal resistance of the remaining grease. New "non-silicone" thermal greases significantly reduce this problem.

Thermal pads, an alternative to thermal grease, are available from a number of manufacturers such as Bergquist, Chomerics, and Aavid/Thermalloy. These thermally conductive pads are available in sheet form or in pre-cut shapes designed for various standard packages such as the TO-126, TO-220 and TO-247. These pads utilize silicone rubber binder combined with a variety of materials such as aluminum oxide, boron nitride, or magnesium oxide to provide good thermal conductivity. For specialized applications pads are laminated with Kapton, fiberglass, or other materials.

Thermal pads are spongy materials and require firm and uniform pressure to perform properly. Charts are available from the pad manufacturers that show the optimum mounting pressure and how reduced mounting pressure will increase thermal resistance.

New materials continue to appear. These include thermal adhesives and tapes, phase change materials, gap fillers and screen printable materials.

Information on thermal management, thermal interface materials and heat sinks are available from the following (Figure 5):

Figure 5

Aavid Thermalloy	www.aavidthermalloy.com
AI Technology	www.aitechnology.com
AOS Thermal Compounds	www.aosco.com
Balkhausen GmbH (Germany)	www.balkhausen.de
Bergquist	www.bergquistcompany.com
Chomerics	www.chomerics.com
Cool Innovations	www.coolinnovations.com
Electronics Cooling	www.electronics-cooling.com
Emerson & Cuming	www.emersoncuming.com
Fujipoly	www.fujipoly.com
Keramische Folien GmbH (Germany)	www.kerafol.com
Kunze Folien GmbH (Germany)	www.heatmanagement.com
Loctite	www.loctite.com
PADA Engineering (Italy)	www.padaengineering.com
Power Devices	www.powerdevices.com
R-Theta	www.r-theta.com
Thermacore	www.thermacore.com
Thermagon	www.thermagon.com
Wakefield Engineering	www.wakefield.com

Hardware Selection

Proper hardware is an extremely important consideration in a good thermal design. The hardware must maintain firm even pressure on the device, through thermal cycling, without deforming the heat sink or the device.

Spring Clips are preferred by many designers in place of screw assembly for attaching Caddock TO-Style Power Resistors to the heat sink. These spring clips are available from several manufacturers. Aavid Thermalloy offers a number of standard springs and heat sinks specifically designed for clip mounting TO-220 and TO-247 packages.

Spring clips offer many benefits for ease of assembly, but their biggest advantage is the consistent application of optimum force over the center of the power resistor (see Figure 6). The following are recommendations for selection of a spring clip.

1. The recommended spring force is 8 to 30 pounds (35 to 130N) applied to the molded package directly over the center of the resistor element.
2. Caddock's MP2060 resistor has been specifically designed for spring clip assembly.
3. Excellent results can be obtained on all Caddock TO-Style Power Resistors with a spring clip assembly and a clean, flat and smooth surface with a thin and evenly spread layer of good quality thermal grease.

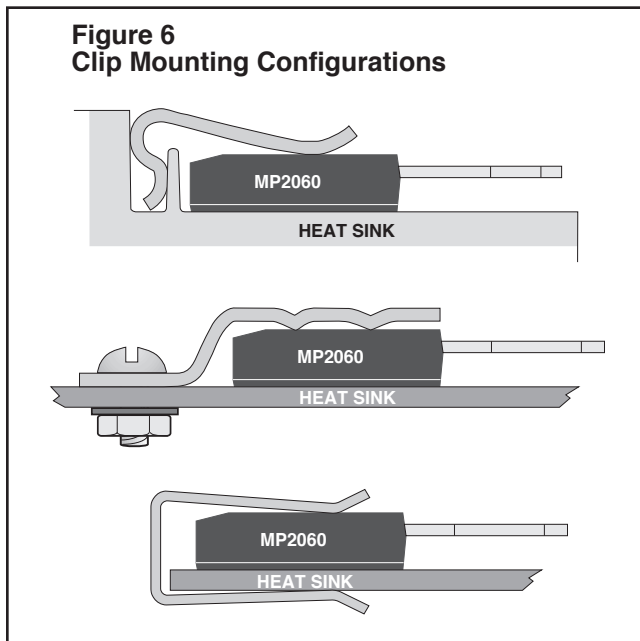

Screw Mounting

Figure 7 shows some typical hardware configurations for screw mounting a TO-Style package to a heat sink. When screw mounting a Caddock TO-Style resistor the following considerations should be observed.

1. Make sure the surface of the heat sink is clean, flat and free of burrs or surface irregularities.
2. Use a good thermal grease or thermal interface material (pad, phase change material, etc) between the resistor and the heat sink.
3. A flat washer should be used between the screw and the package to help spread out the mounting force, this is especially important on the molded package styles.
4. Use a spring washer such as a conical washer (Belleville Washer) or similar spring washer to maintain adequate pressure during the operating life of the product and through temperature cycling and variations.

Do not overtighten the mounting screw. The maximum torque for TO-220 style package is typically 8 in-lb or 1.1 n-m. For recommended and maximum mounting torques please see the data sheet for the Caddock resistor model in questions. **CAUTION:** Grease on the threads, variations in thread depth, pitch, and tolerances can effect torque measurements. We do not recommend using torque limits without first testing your specific application to assure that proper deflection of the washer is maintained.

Belleville or Conical Washers used with a screw are an effective method for attachment to a heat sink. A Belleville washer is a conical spring washer designed to maintain constant pressure over a wide range of deflection. The washers withstand long-term temperature cycling without variation in pressure. The large open end of the washer should face the device or heat sink that it contacts. Flat washers, star washers, and most split lock washers should not be used in place of Belleville washers since they do not provide a constant mounting pressure and may cause damage to the resistor.

When screw mounting a TO-220 package, a force of 125 to 350 pounds (550 to 1500 N) is necessary for optimum heat transfer. Most commonly available Belleville washers cannot provide enough force and will flatten out, rendering them useless.

It is very important that this force is carefully controlled and uniformly distributed to avoid lifting the edge of the resistor or cracking the package. A common cause of resistor failure is breakage caused by excessive force applied over a small area. This can happen when proper mounting torque is not applied.

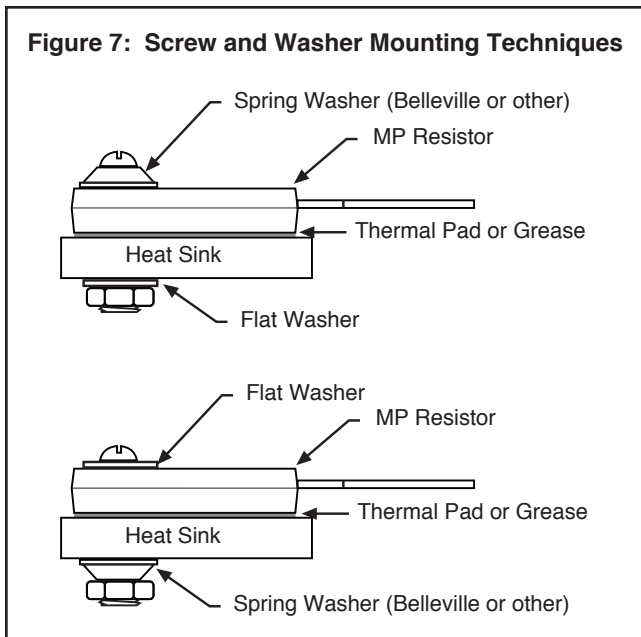

Assembly Considerations

1. Never let the head of the screw contact the resistor. Use a flat washer or conical washer to evenly distribute the force.
2. Do not over-torque. If the screw is too tight, the package may crack or have a tendency to bow up at the end farthest from the screw (lead end). Pneumatic tools are not recommended.
3. Avoid sheet metal screws which have a tendency to roll up the edges of the hole and create damaging burrs on the heat sink.
4. Rivets are not recommended. With rivets it is difficult to maintain consistent pressure and they can easily damage plastic packages.
5. Plastic mounting hardware that softens or creeps at high operating temperatures must be avoided.
6. Avoid using this TO-Style family of power resistors for SMT assembly. For surface mount requirements, use Caddock MP725 D-Pak Style power film resistors, Type CC or Type CD chip resistors.

8.0 LEAD FORMING

Improper lead forming may damage the resistor package, but can be done if proper care is taken. The MP820 and MP821 are the most versatile choices due to the round leads. Lead bending on all other packages, with flat leads, should be limited to the vertical axis. If SMT formed leads are required, the MP725 (D-PAK style package) with SMT formed leads and a solderable tab is available.

1. Always provide strain relief when lead forming. While forming, the leads must be supported or gripped between the bend and the package.
2. The minimum bend radius is 0.050". Forming a tighter radius can crack the plating and/or weaken the lead. Using a mandrel or forming fixture is recommended.
3. Do not twist the leads at the body of the resistor.
4. Generally, do not splay the leads (bend outwards, parallel to the heat sink mounting plane). This may be done on the MP820 or MP821 only.

9.0 THERMAL DESIGN VERIFICATION

Always verify your thermal design with actual temperature measurements of the prototype. These measurements must consider the maximum power dissipation, maximum ambient temperature, and assembly variables.

Case temperature (Figure 1) is the best measurement for design verification, since by calculations (Equation 1) the film temperature (T_J) can be determined. However, case temperature is often difficult to measure.

Alternate temperature measurements, described below, can give a general indication of the film temperature. These alternate temperature measurements will always be lower than the film temperature (T_J), since the film is the heat generating source. Therefore, these alternate temperature measurements must be well below the maximum rated operating temperature of the resistor.

An alternate temperature measurement can be made at the leads where they exit the resistor body (lead temperature see Fig. 1) or on the metal tab adjacent to the plastic package (tab temperature MP820/821 see Fig. 1). A measurement of 100°C would be very safe, when measured at the highest ambient temperature and highest average power for the design. For temperature measurements, use a low mass thermocouple probe that will not sink heat away from the measurement point on the resistor. A thin layer of thermal grease on the thermocouple will assure good thermal contact.

For temperature measurements other than case temperature, consider the following issues. Refer to Figure 1 for these measurement locations.

Lead temperature measurements can approach the film temperature, but are always cooler. Some board materials, a large copper bus or heavy copper pads can provide heat sinking which lowers temperature of the leads. Leads should always be measured at the hottest point closest to the body and this temperature compared to the “hottest spot” molded body temperature.

Metal “tab temperature” adjacent to the molded resistor body provides a good means of estimating the case temperature of a metal tab TO-220 resistor. The temperature should be measured at the hottest spot along the tab/body interface. This temperature will be about 1°C/W cooler than the case temperature (T_C).

Example:

The metal tab temperature measures 50°C on an MP820 ($R_{\theta JC}=7.5^\circ\text{C/W}$) operating at 10 watts at maximum ambient temperature.

$$T_J = 50^\circ\text{C} + (10\text{W} \times (7.5^\circ\text{C/W} + 1^\circ\text{C/W})) = 135^\circ\text{C}$$

The film temperature (T_J) is safely below the maximum temperature rating of 175°C .

Heat sink temperature can provide an indication of case temperature, but very easily provides false data. A cool heat sink and a hot resistor can indicate poor mounting caused by improper mounting force, thick or poor quality grease, burrs or poor mounting surfaces, any of which can reduce the flow of heat from the resistor to the heat sink.

Case temperature (T_C) provides the most accurate estimate of the resistor element temperature (T_J) but can be difficult to measure (Figure 1). The resistor element temperature (T_J) will exceed the case temperature by an amount which can be calculated using the power applied (P_D) and the thermal resistance ($R_{\theta JC}$) of the part.

Example:

The case temperature measures 75°C on an MP930 ($R_{\theta JC} = 4.17^\circ\text{C/W}$) operating at 6 watts at 25°C ambient temperature.

$$T_J = 75^\circ\text{C} + (6\text{W} \times 4.17^\circ\text{C/W}) = 100^\circ\text{C}$$

The film temperature is 100°C.

What if the system is to operate at 70°C ambient temperature? This is 45°C above the original ambient temperature (70°C-25°C). The resistor element will then be 145°C (100°C + 45°C). The MP930 with a maximum temperature rating of 150°C is an acceptable but marginal choice, considering the variations of mounting, thermal grease thickness, etc. The MP2060, MP850 or MP9100 would be a more conservative design.